

**Other Lectern Sound and Non-Sound from Oklahoma Sound Corp.**



MODEL # 950/901/910



MODEL #111 PLS



MODEL #222



#SCL

*For these and other OSC accessories, please contact your dealer, or:*

**OKLAHOMA SOUND CORP.**

149 Entin Road, Clifton, NJ 07014

Tel: 973-594-9000 • Fax: 973-594-9339

Web-Site [www.oklahomasound.com](http://www.oklahomasound.com) • e-mail: [info@oklahomasound.com](mailto:info@oklahomasound.com)



**OKLAHOMA SOUND CORP.**

# THE VISION

## PRODUCT HANDBOOK













**MODEL # 612**

## INTRODUCTION

**Congratulations!!!** On your purchase of the Vision Lectern. The perfect lectern solution for customizing logos for your institution or presentation slideshows. Designed with a sleek curved shape in a modern cherry laminate, that provides a contemporary look for a variety of venues, **The Vision** is furnished with breakthrough technology; a 15-inch LCD screen built into the front of the unit. Your screen has the ability to display images uploaded with a SD-card or flash drive. It includes a remote control, allowing the presenter to switch to various preloaded images with a touch of a button during a presentation or between speeches. This integrated system can be used to display customized logos in your school, hotel or place of worship. Additionally, it enables a speaker to bring a presentation to life by displaying diagrams and photos for the audience. This beautifully hand crafted lectern is built with a 3/4-inch stain and scratch resistant wood grain thermofused melamine laminate on MDF. The unit is equipped with two shelves for ample storage and moves easily with four concealed casters, two locking and two non-locking.

### Hardware included:

- 4 Casters (2 Locking– 2 Non-locking) 
- 10 Cam Locks 
- 10 Cam Bolts 
- 6 L Brackets 
- 2 Z Brackets 
- 24 Black #8 Screws for L Brackets 
- 16 Black #8 screws for the casters 
- 12 Black #8 screws to attach Z brackets to front panel. 
- 4 Black bolts, washers, and nuts to attach screen to bracket. 
- 4 Shelf supports for the adjustable shelf 

### Tools Needed:

- Phillip Screwdriver 
- Small wrench to tighten nuts for the Z brackets

### Dimensions

Overall.....46H" X 24"W X 21"D  
 Interior shelf.....14.5"D X 23"W  
 Screen.....15inch  
 Weight.....97LBS



### Maintenance and Precaution

- The Digital Picture Frame is for indoor use only.
- To reduce the risk of fire or electric shock; do not expose this appliance to rain or moisture.
- Do not block the ventilation holes on the back of the Digital Picture Frame at any time.
- Keep your Digital Picture Frames out of sunlight. Direct sunlight may cause damage.
- Do not open the case of the Digital Picture Frame. There is a risk of electric shock, and there are no user serviceable parts inside. Opening the case will void your warranty.
- Do not use the Digital Picture Frame if conditions could allow condensation to occur, or damage may result.
- Your Digital Picture Frame is a complicated electronic device and cannot withstand shock from drops.

### Cleaning the LCD screen

- Treat the screen gently. The screen on the Digital Picture Frame is made of glass and can be scratched or broken.
- If fingerprints or dust make the LCD screen dirty, we recommend using a soft, non-abrasive cloth such as a camera lens cloth to clean the LCD screen.
- If you use an LCD Cleaning Kit sold on the market, apply the cleaning liquid to the cloth. Do not apply the liquid directly to your LCD screen.

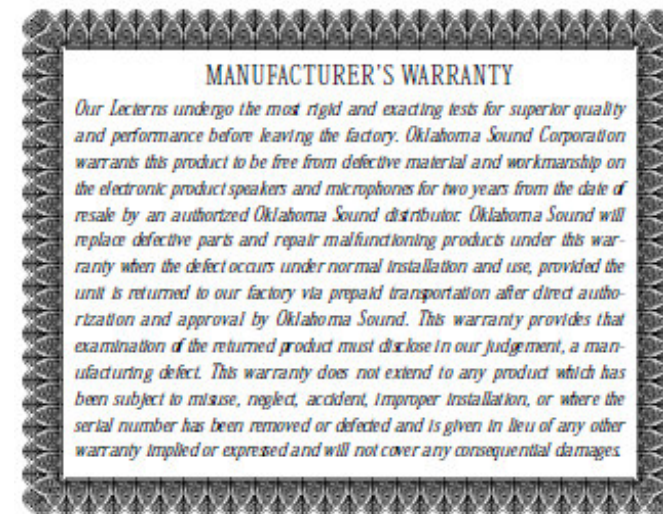

**NOTE: THE LECTERN IS COVERED BY A TWO YEAR WARRANTY.  
 THE SCREEN IS COVERED BY A ONE YEAR WARRANTY.**

- **Q: Can I use touch-enabled technology for my Digital Picture Frame?**  
**A: The LCD screen does not support touch-enabled technology. Please use the buttons or remote control to control the Digital Picture Frame.**
  
- **Q: If I keep showing the same photo for a long time, will it damage the LCD screen?**  
**A: No. The Digital Picture Frame can display the same photo continuously for a long time. But it is recommended not to show the same picture continuously for more than 1 month.**
  
- **Q: What is the maximum picture size?**  
**A: The Digital Picture Frame is able to display pictures up to 12 Mega Pixels.**
  
- **Q: What is the best picture resolution displayed on the screen?**  
**A: The frame's best resolution is 1024x768.**
  
- **Q: How come the Digital Picture Frame does not show some of my photos?**  
**A: The Digital Picture Frame is designed to show photos following the same camera industry standards format as digital cameras. This format is a JPEG format. Images, such as web images, scanned images, or photos in RAW format, are not stored according to camera industry standards and therefore cannot be displayed correctly on the Digital Picture Frame. Please use your PC applications to convert such images into standard JPEG format before viewing them on the Digital Picture Frame.**

Troubleshooting

Symptom	Cause	Corrective Actions
Digital Picture Frame doesn't power on.	The Power connector to the unit is not securely inserted.	Please be sure that the AC adaptor is properly connected to the frame.
Unable to insert memory card	Memory card inserted in the incorrect slot or in the incorrect direction.	Insert the correct card in the correct slot and direction.
Power is on but the Start-Up screen is not displayed.	System does not work normally	Restart the Digital Picture Frame.
No photo, videos, or music files on memory card.	Memory card is not inserted correctly.	Insert a supported memory card.
No sound from the speakers.	The volume may be in the lowest level; it may be in mute mode.	Confirm the volume is properly adjusted or press MUTE button to exit mute mode.
No background music when slideshow pictures	Background music is off	Press BACK MUSIC button or enter COMBO mode to slideshow pictures.
The files do not play.	Incompatible File Formats.	Make sure there is at least one supported file format on the memory card.
Can not copy or delete files.	The files or memory card are locked.	Unlock the files or memory card.
Remote control does not work.	No battery or weak battery in the remote control.	Insert or change the battery in the remote control.

Hardware and Screen Assembly:

1. Begin by laying out all the panels on a clean soft surface with the pre-drilled holes facing up. Insert all cam locks and cam bolts. Be sure to insert the cam locks with the small arrow facing toward the opening on the side of the panel for the cam bolt to be inserted easily. (See diagram 1)

Diagram 1

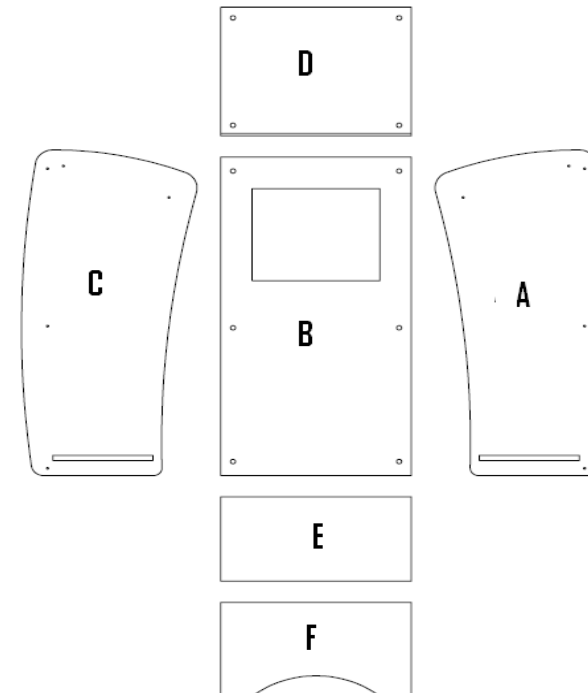

2. Continue by taking the LCD screen out of the box. Place the screen face down on a clean and soft surface, so not to scratch the frame. Take the front panel B and gently place the panel over the screen so the back of screen fits through the cut-out. Be sure that the censor (small circle) on the wood frame on the front of the screen is on the bottom of the panel. The screen will not be flush to the front panel. It should stick out 1/4 of an inch.

3. Take the four small black bolts and place them in the four holes in the back of the screen. (See diagram 2).

Diagram 2



Diagram 3

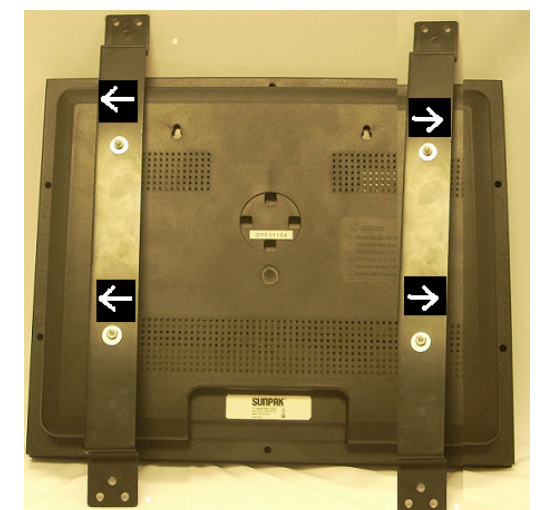

1. Place the two Z brackets over the back of the screen and have the four bolts go through the two holes on each of the brackets. Continue by taking the four nuts and washers and thread them through the bolts loosely.
2. Push each bracket to the outer side so the nut will be firmly nudged into the mounting crevice in that back of screen. The top and bottom of the Z bracket should align with the predrilled holes on the back of the front panel. Be sure to align the holes on the top and the bottom of each bracket to the predrilled holes in the back of the front panel directly above and under the screen cutout. (See diagram 3)
3. Once the bolts are in the correct place continue by tightening the nuts as tight as possible.
4. Screw the Z brackets into the predrilled holes using the small black screws provided.
5. On the "BOTTOM PANEL (F)" screw in the four casters. The locking casters should be screwed into the predrilled holes closest to the shaped finished edge, The second pair of non-locking casters should be screwed into the predrilled holes closest to the unfinished edge.
6. Screw the 6 L braces to the bottom panel F into the predrilled holes. There should be two on each side and two on the back.

### Assembly of Lectern:

1. The first step is to align the holes on the edge of the panel B with the three cam bolts on the side panel A. Insert the front panel gently until the panel is completely flush with panel A and tighten the cam locks. (See diagram 4)

**Diagram 4**

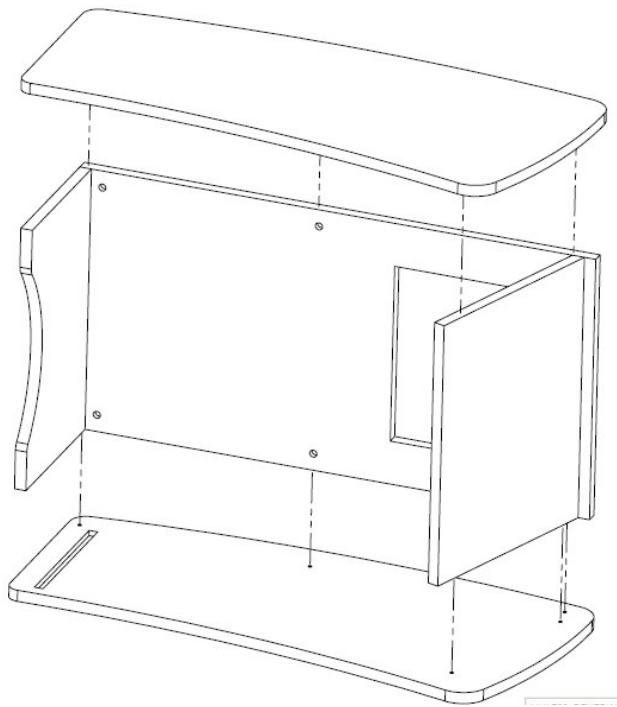

2. Continue by repeating the above procedure with Panel D.

3. Take Panel F (with the wheels towards the bottom of the unit) and insert snugly into the groove on the bottom of side panel A.

4. Proceed by aligning all the cam bolts on the left panel C with holes on the edge of panel B and D and gently insert all of the bolt into the holes and tighten the cam locks.

5. Screw the 6 L brackets on the bottom of panel F to panels A, B and C.

6. Go over all the cam locks and double check that they are all as tight as possible to ensure that the lectern is as stable as can be.

**Congratulations you have successfully assembled your lectern!!**

**Caution: When rolling your lectern from room to room always do so with care by holding the unit firmly with both hands to avoid the lectern from tipping over. The unit should never be moved by a child under 12 years old.**

### Screen Instructions and Functions

**Below are some important points on how to operate the screen effectively.**

1. The order in which you load your logos on to a USB Flash drive is the order in which they will appear. This is the case even if it appears on your computer that the order is different, the screen will display it in the order that the images were loaded onto the stick.
2. To have your logo displayed and frozen on the screen, press the pause button on the remote. To move the screen to the next logo or image in queue, press the right arrow once. If you press the play button this will continue to display the images in a slide show format in the intervals set in your Setting menu option.
3. The remote works best when you direct the remote at the censor button on the front of the frame.

Sunpak SF-150-42001SL 15" TFT LCD Digital Frame



#### Using your Remote Control

The following table briefly describes the remote control functions

Button	Description
Power	Turn on/off
Photo	Access your photo files
Music	Access your music files
Video	Access your videos files
Combo	Start the slideshow
Time	Display the time/ Calendar
Mute	Mutes volume
Menu	Displays the main menu
Enter	Select highlighted item
VOL +/-	Adjusts volume
Arrows	Navigate on screen
▶/	Play/ pause



#### Inserting Memory Cards

The Digital Picture Frame is compatible with the following memory cards:

- Secure Digital™ Card (SD)
- MultiMedia™ Card (MMC)
- Memory Stick™
- CompactFlash™ (CF) Card
- XD Picture Cards

Insert the memory card with the front label facing AWAY from you. Do not force the memory card into the memory slot. If you are not able to easily insert the memory card completely, you may have inserted it the wrong way.

Note:

The Digital Picture Frame will ONLY recognize digital pictures stored in JPEG format. Digital pictures stored in other formats will be ignored by the device.

Make sure you have at least one picture stored on the memory card. The frame will not function properly without a stored picture.

You also can use a USB flash drive in the exact same way as you would use a memory card. Simply copy files on the flash drive and insert it at the right side of the unit in the USB Host plug.